

deski kompozytowe -  
taras

plytki ceramiczne -  
łazienki

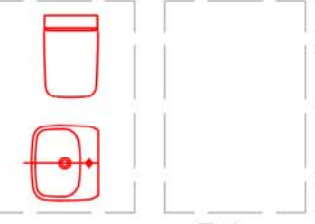

wykładzina dywanowa -  
pokoje

ceramika sanitarna nowa



umeblowanie

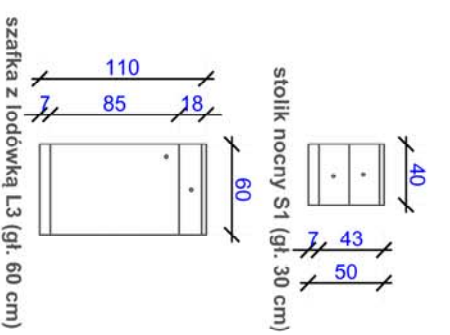
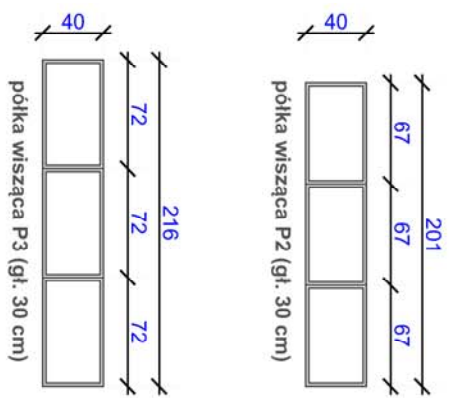
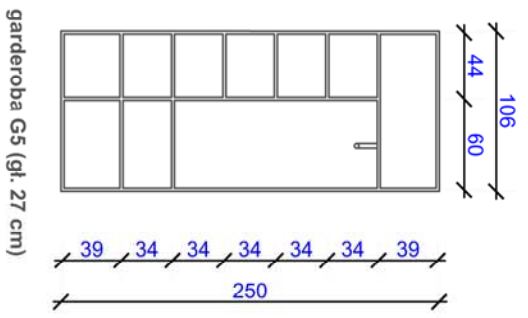
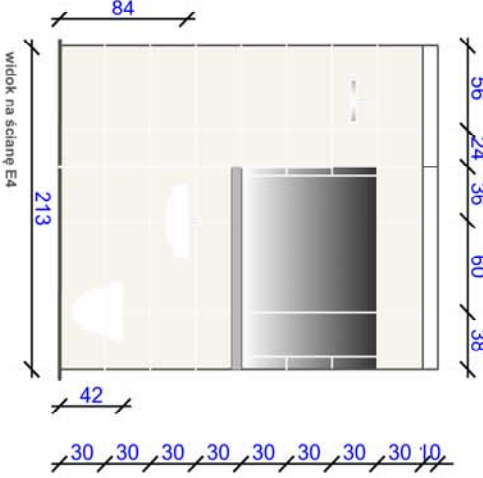
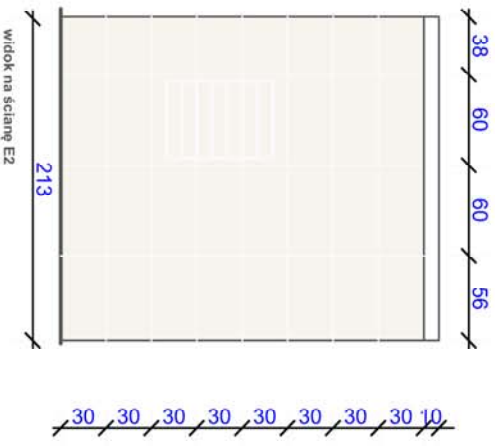
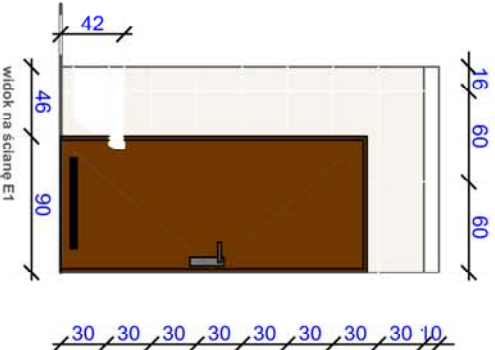

<b>Biuro Architektoniczno-Consultingowe "BIARCO"</b> ul. Zakopiańska 512, 58-560 Jelenia Góra tel. +48 604 180 170 biuro: ul. 1 Maja 14, 58-500 Jelenia Góra		<b>Aranzacja Jednostki 810</b> ul. Kopernika 14 58-580 Szklarska Poręba	
<b>Projektant:</b> mgr inż. arch. Bogna Skrzydlewska-Antos upr. nr 2763/94/J.G.		<b>Skala:</b> 1:50	
<b>Projekt:</b> MODERNIZACJA KORYTARZA I POKOI MIESZKALNYCH NA POZIOMIE VIII WRAZ Z PRZYLEGAJĄCYMI TARASAMI - CZ. WSCH. W BUDYNKU CRR KRUS "GRANIT" W SZKLARSKIEJ PORĘBIE PRZY UL. KOPERNIKA 14 (dz. nr 119/2, obr. 0004, jedn. ew. 020504.)		<b>nr rysunku:</b> A-7	
<b>Investor:</b> Centrum Rehabilitacji Rolników CRR "KRUS" ul. Kopernika 14 58-580 Szklarska Poręba		<b>data:</b> 15 grudnia 2018 r.	